



- Insertion resistance thermometer with connector, transmitter and optional plug-on display
- Thread and welded resistance thermometers according to DIN with removable measuring elements
- Contact-resistance thermometer
- In-line temperature detector for hygienic applications
- Averaging resistance thermometer
- Sheath resistance thermometer
- Special probes to customer specification



KOBOLD offices exist in the following countries:

ARGENTINA, AUSTRIA, BELGIUM, BRAZIL, CANADA, CHINA, FRANCE, GERMANY, GREAT BRITAIN, ITALY, MEXICO, NETHERLANDS, PERU, POLAND, SWITZERLAND, USA, VENEZUELA

KOBOLD Messring GmbH
Nordring 22-24
D-65719 Hofheim/Ts.
☎ +49(0)6192 299-0
☎ +49(0)6192 23398
E-Mail: info.de@kobold.com
Internet: www.kobold.com

Basic principles:
Resistance thermometers

Temperature-dependant resistance

Resistance thermometers use the continuous change in resistance of metals with changing temperature. Due to its good stability and repeatability, platinum is mainly used today as resistor material.

The temperature coefficient of platinum is positive, that is, the resistance increases with rising temperature.

It also has the advantage of a high degree of chemical resistance and it can be easily worked.

In order to assure universal replacement, these properties are defined in the IEC 751 standard.

Limits of deviation

Two tolerance categories for deviation are specified in IEC 751: category A and category B.

Expected tolerance categories

Practice has shown that the two tolerance categories set out in the standard are not sufficient for particular applications. Based on the standard tolerances, the tolerance categories have been subdivided further so as to meet the varied requirements of the market.

| Tolerance category | Temperature range | Tolerance (K) | Tolerance at | |
|--------------------|-------------------|---------------------------------|--------------|-------------|
| | | | t=0°C | t=100°C |
| 1/3 category B | -70 ... +250°C | $\pm (0.10K+0.0017 \times t)$ | $\pm 0.10K$ | $\pm 0.27K$ |
| category A | -200 ... +600°C | $\pm (0.15K+0.0020 \times t)$ | $\pm 0.15K$ | $\pm 0.35K$ |
| category B | -200 ... +850°C | $\pm (0.30K+0.0050 \times t)$ | $\pm 0.30K$ | $\pm 0.80K$ |
| category 0.5 | -200 ... +850°C | $\pm (0.50K+0.0060 \times t)$ | $\pm 0.50K$ | $\pm 1.10K$ |

|t|=measuring temperature in °C without sign

Design of resistance thermometers

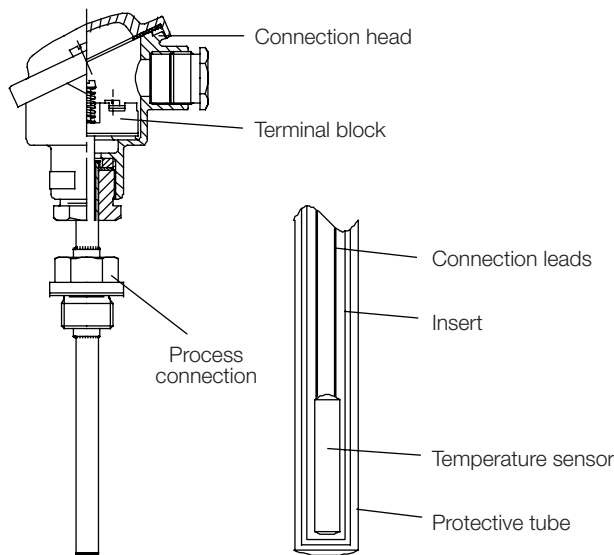

The measuring inserts are manufactured as single or double versions. Their dimensions are defined by the standard DIN 43 762. Measuring inserts with integrated two-wire transmitters are also available.

If no measuring insert is used, the temperature sensor is embedded in aluminium oxide or heat-transfer compound in the protective tube.

The sensor cannot then be replaced at a later date, the complete resistance thermometer must be replaced in this case.

Connection heads models A and B are defined in DIN 43729. The smaller connection head form B, for which the two-wire transmitter has also been designed, is more commonly used.

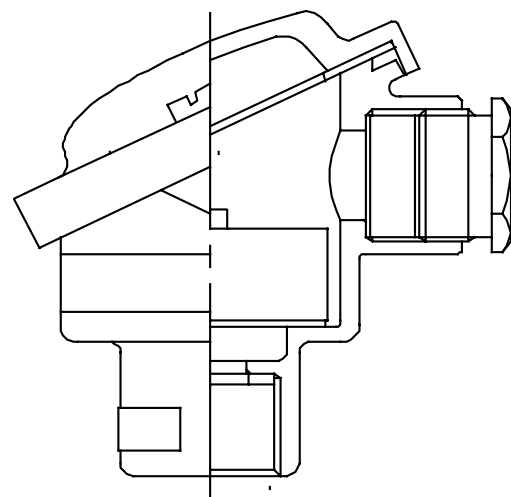

In addition to the vast range of special versions available, there are some whose parts are fully described in the standards.

Resistance thermometer with connection head

This resistance thermometer consists of measuring insert, protective tube, connection head containing and connection base and possibly flanges or clamp fittings.

Protective tube constructions

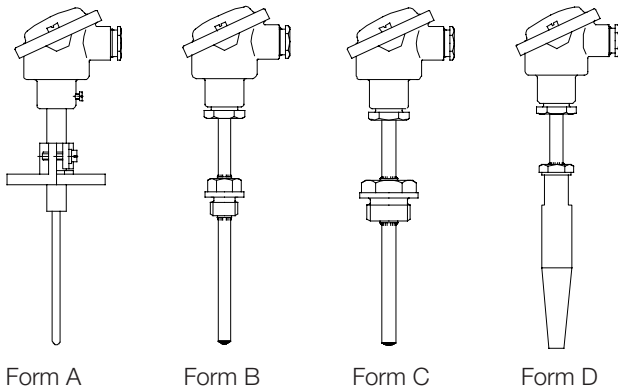

Thermometer according to DIN 43770

Different protective tube constructions for resistance thermometers are defined in the standards 43764 to 43769. They are all fitted with a measuring insert and a connection head of form B. The diameters and lengths of the protective tubes are also defined.

- Form A:** Tube for mounting with sliding stop flange for flue-gas measurements
- Form B:** Tube with thread G 1/2 A
- Form C:** Tube with thread G 1 A
- Form D:** Pressure-resistant, thick-walled tube for welding connection
- Form F:** Tube tapered at end for quick-response performance for mounting with welded flange
- Form G:** Tube as in form F, however with welded thread G 1 A

A variety of special forms are also available, some with standard connecting heads, others in very special, non-standard designs with plug connections or permanently mounted connecting lead.

Resistance thermometers with two-wire transmitter in the connection head

Resistance thermometers with transmitter for measuring temperature in liquid and gaseous media are used when measuring signals are to be transmitted noise-free over long distances. The transmitter transforms the sensor signal into a normalized, temperature-linear current signal of 4 ... 20 mA.

Resistance thermometers with connecting lead

The temperature sensor in resistance thermometers with connecting lead is directly attached to the connecting lead and inserted in the protective tube. (The end of the protective tube is partly curled many times or pressed (protection type IP 65) to relieve strain.) The interior between protective tube and temperature sensor is typically filled with a heat-conducting material, so as to improve the thermal contact with the measured medium.

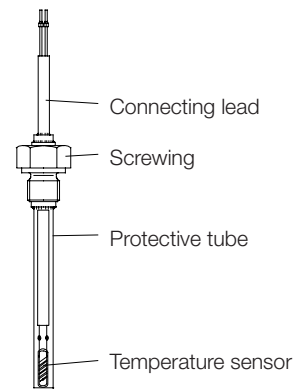

Construction of a resistance thermometer with connecting lead

Sheath resistance thermometers

Sheath resistance thermometers are based on a mineral-insulated light sheathed cable. The inner copper cables are embedded in pressed fireproof magnesium oxide in the thin-walled light sheathed made of stainless steel. The **temperature sensor** in two-, three- or four-wire circuitry is attached to the inner cables and fitted in the protective tube made of stainless steel. Protective tube and light sheathed cable are welded together. Diameters start at 1.9 mm.

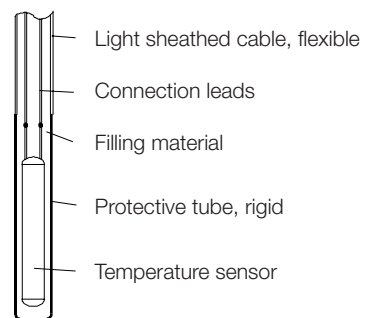

Construction of a sheath resistance thermometer

Very good heat transfer between **protective tube** and temperature sensor allows fast response times ($t_{0.5}$ from 1.2 s) and high measuring accuracies. The vibration-proof design assures long service life. The flexible light **sheathed cable**, minimum bend radius 5 x external diameter, allows temperature measurements at locations that are difficult to access.

Connection of Resistance Thermometers

The electrical resistance in resistance thermometers changes with temperature. The voltage drop caused by a constant measuring current is measured in order to record the output signal.

The smallest measuring current possible should be selected so as to prevent the sensor from heating up. It can be assumed that a measuring current of 1 mA will not cause any significant impairment. This current gives rise to a voltage drop of 0.1 V in a Pt 100 at 0°C. This measuring voltage must be transmitted as valid as possible by the connecting leads to the display or evaluation location. Three different wiring techniques are available:

Two-wire circuitry

Evaluating electronics and thermometer are connected with a two-core cable. Just like every other electrical conductor this cable contains a resistance that is connected in series with the temperature sensor. Thus both resistances are added and a systematically higher temperature is displayed. The line resistance can be in the order of some ohms over long distances – thus significantly invalidating the measured value.

To prevent this fault the line resistance is compensated by electrical means: the device electronics is designed so that the line resistance is assumed to be 10 Ω, for example.

To connect the resistance thermometer, a trimming resistor is connected in one of the measuring lines and the sensor is temporarily replaced with a 100 Ω resistance. Now the trimming resistance is adjusted until 0°C is displayed on the device. Due to this comparatively laborious trimming exercise and the fact that the temperature effect on the measuring line is not taken into account, the use of two-wire circuitry is in decline.

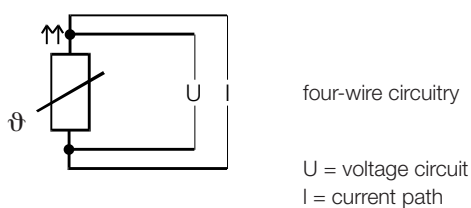
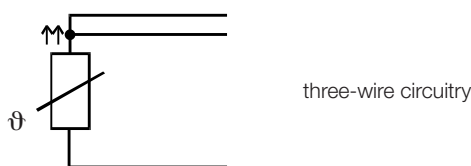

Three-wire circuitry

The influences of line resistances and their temperature-dependant variations are minimized with three-wire circuitry. In this case an additional cable is connected to a contact on the resistance thermometer. Two measuring circuits are thus achieved, one of which serves as a reference. The value of the line resistance and its temperature dependence can be compensated by means of the three-wire circuitry. All three cores must have identical properties and the same temperatures. Because this is the case in most situations, three-wire circuitry is the most commonly used method nowadays. Line compensation is not required. The output need not be adjusted.

Four-wire circuitry

Four-wire circuitry is an optimum connection technology for resistance thermometers. The measurement results are not impaired by the line resistances or their temperature-dependant variations. Line compensation is not required. The thermometer is supplied through the supply leads with the measuring-current I. The voltage drop U at the temperature sensor is picked off from the measuring lines.

If the input resistance of the downstream electronics is very much greater than the line resistance, this should be ignored. The voltage drop thus determined is then independent of the characteristics of the supply leads.

Resistance values for Pt100 sensors in Ω

| Temp. °C | 0 | 10 | 20 | 30 | 40 |
|----------|--------|--------|--------|--------|--------|
| 0 | 100.00 | 103.90 | 107.79 | 111.67 | 115.54 |
| 50 | 119.40 | 123.24 | 127.07 | 130.89 | 134.70 |
| 100 | 138.50 | 142.29 | 146.06 | 149.82 | 153.58 |
| 150 | 157.31 | 161.04 | 164.76 | 168.46 | 172.16 |
| 200 | 175.84 | 179.51 | 183.17 | 186.82 | 190.45 |
| 250 | 194.07 | 197.69 | 201.29 | 204.88 | 208.45 |
| 300 | 212.02 | 215.57 | 219.12 | 222.65 | 226.17 |
| 350 | 229.67 | 233.17 | 236.65 | 240.13 | 243.59 |
| 400 | 247.04 | 250.48 | 253.90 | 257.32 | 260.72 |
| 450 | 264.11 | 267.49 | 270.86 | 274.22 | 277.56 |
| 500 | 280.90 | 284.22 | 287.53 | 290.83 | 294.11 |
| 550 | 297.39 | 300.65 | 303.91 | 307.15 | 310.38 |
| 600 | 313.59 | 316.80 | 319.99 | 323.18 | 326.35 |