

Table of contents

	Page
Overview NT 4500/ NT 4600	2

NT 4500 Level monitoring and visualisation via web server	4

NT 4600 Level monitoring and visualisation via touch panel	6

NT 4700 Level display for one silo	8

NT 4900 Digital display	9

Accessories	10

Subject to change.

All dimensions in mm (inches).

All prices in Euro (€) or USD (\$),
excluding VAT.

All EURO prices are EXW Betzigau,
all USD prices are EXW Memphis,
excluding packaging costs.

Valid: From 01.04.2020 until 31.03.2021, unless otherwise agreed.

By publishing this selection list all other lists become invalid.

We assume no liability for typing errors.

Different variations to those specified are possible.
Please contact our technical consultants.

Overview NT 4500 / NT 4600

Standardized Level monitoring system up to 30 silos

Silo plant with continuous level measurement technology and full detectors

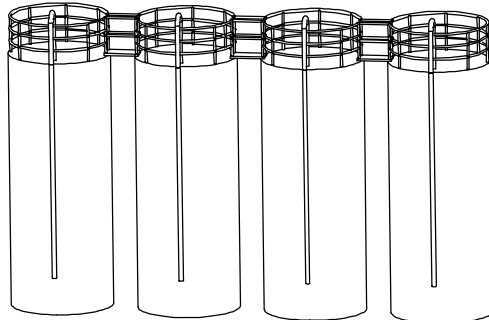

Alarm "Silo full"

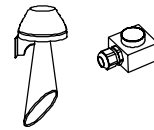

Modbus converter

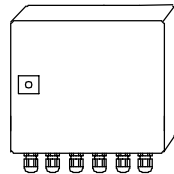

4-20 mA,
full detector signal

Modbus RTU

alternative*

NT 4600
Visualisation
with
touch panel

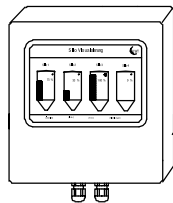

NT 4500
Webserver

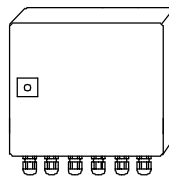

Ethernet



Remote data enquiry

Visualisation with PC via standard internet browser

* Mixed use of NT 4500 and NT 4600 is not possible

Overview NT 4500 / NT 4600

Technical data	
Dimensions	NT 4500/ NT 4600, Modbus converter: 300 x 300 x 155 mm (W x H x D)
Mounting	NT 4500/ NT 4600, Modbus converter: wall mounting
Material	NT 4500/ NT 4600, Modbus converter: steel plate
Ingress protection	NT 4500/ NT 4600, Modbus converter: IP65
Ambient temperature	NT 4500: 0 .. +55°C NT 4600: 0 .. +50°C Modbusumsetzer: -25 .. +70°C
Power supply	NT 4500/ NT 4600, Modbus converter: 115 V or 230 V 50/ 60 Hz (integrated power converter 24 V DC) NR 3000: supplied by Modbus converter NB 3000/ NB 4000: 15 V or 230 V AC, connection is made on site Full detector: connection either on NB 3000/ NB 4000 resp. Modbus converter. In this case the supply voltage must be equal to NB 3000/ NB 4000 resp. Modbus converter. Alternative it is possible to connect on site.
Power consumption	NT 4500/ NT 4600, Modbus converter: 20 VA
	Connected level sensors: see documentation of the respective sensors
Signal output full detector	Floating contact is required

NT 4500

Level monitoring and visualisation via web server

- Standardised system up to 50 silos
- Visualisation and operation via standard internet browser software
- Software language: German or English
- Password protected
- Worldwide remote enquiry of the level
- Data in percentage, height, volume or weight
- Trend display, data storage, export via .csv
- Evaluation of the analogue 4-20 mA signals of any sensors, as well as Modbus RTU of the UWT-systems
- Different input signals within the same system is possible
- Implementation of full detectors
- Fill control via full alarm signal (buzzer)

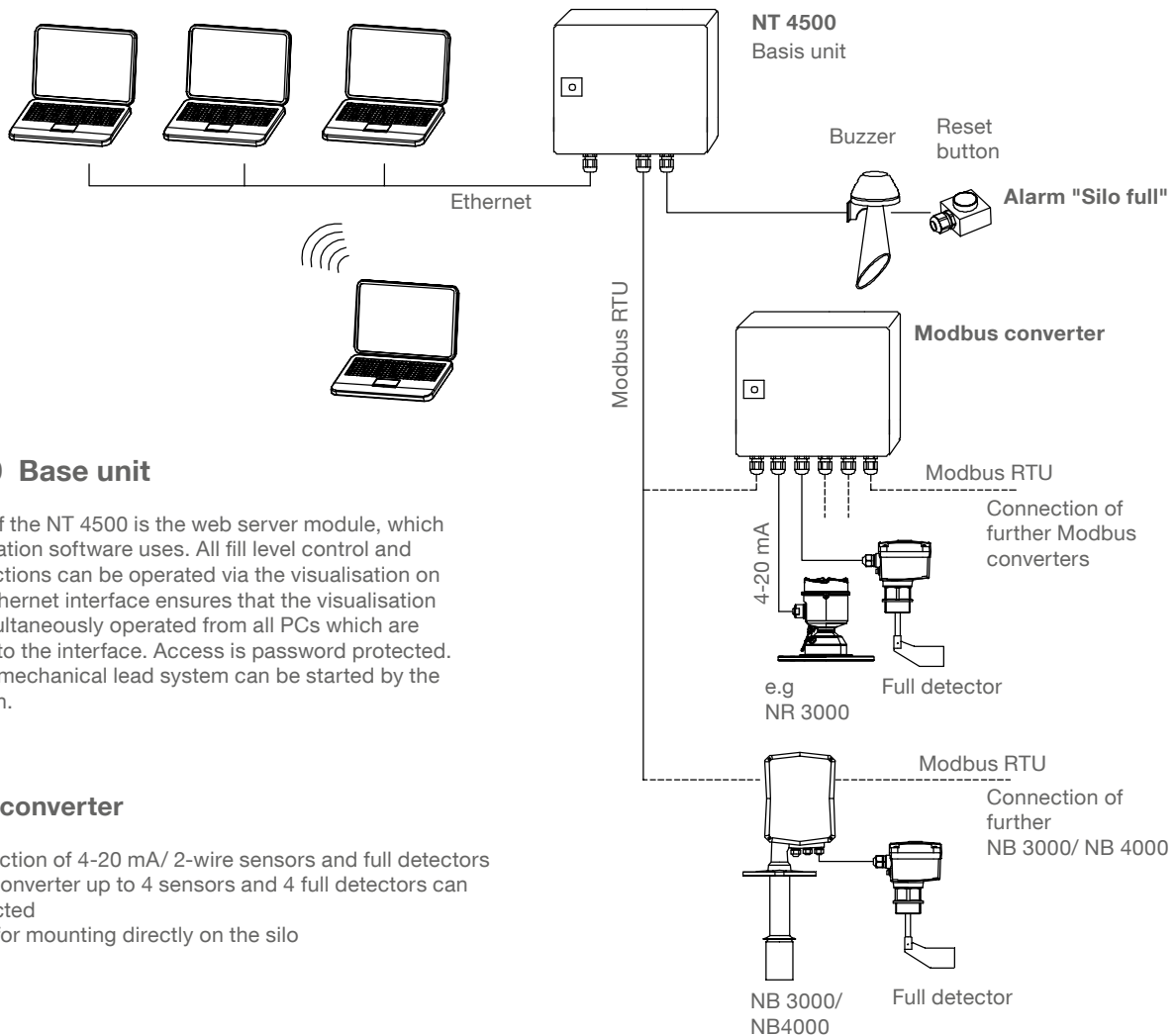

NT 4500 Base unit

The heart of the NT 4500 is the web server module, which the visualisation software uses. All fill level control and display functions can be operated via the visualisation on a PC. An Ethernet interface ensures that the visualisation can be simultaneously operated from all PCs which are connected to the interface. Access is password protected. The electromechanical lead system can be started by the visualisation.

Modbus converter

- For connection of 4-20 mA/ 2-wire sensors and full detectors
- On each converter up to 4 sensors and 4 full detectors can be connected
- Provided for mounting directly on the silo

Integration of full detector incl. alarm "silo full"

- Buzzer with reset button (supplied loose, for outdoor mounting)
- One unit for all connected silos
- Alarm happens, if one of the silos gets full
- Reset of the alarm
- Provided for mounting directly on the silo

Technical data
 see page 3

NT 4500

Basic unit								
NT 4500								•
pos.1	Control cabinet - max. number of silos							
	A	Webserver without control cabinet, pre-wired on a top hat rail - max. 25 silos						•
	B	Webserver without control cabinet, pre-wired on a top hat rail - max. 50 silos						•
	C	Webserver in a control cabinet - max. 25 silos						•
	D	Webserver in a control cabinet - max. 50 silos						•
pos.2	Input signals of level sensors							
	1	Modbus RTU (NB 3000/ NB 4000)						•
	2	4-20 mA 2-wire (e.g. NivoRadar NR 3000), use of Modbus converter						
		Price for each 4 silos						•
	3	Mixed used: Modbus RTU/ 4-20 mA 2-wire						
		Price for each 4 silos with 4-20 mA units						•
pos.3	Integration of full detector incl. alarm "silo full"							
	0	without						•
	A	with						•
pos.4	Software language							
	A	German						•
	B	English						•
pos.5/ 6	Number of silos (max. 25/ 50)							•

Basic unit	Position					
NT 4500						← Order code
	1	2	3	4	5/6	



NT 4600

Level monitoring and visualisation via touch panel

- Standardised system up to 15 silos
- Visualisation and operation via 7" touch panel (coloured, 800 x 480 pixel)
- Software language: German or English
- Password protected
- Data in percentage, height, volume or weight
- Trend display, data storage
- Evaluation of the analogue 4-20 mA signals of any sensors, as well as Modbus RTU of the UWT-systems
- Different input signals within the same system is possible
- Implementation of full detectors
- Fill control via full alarm signal (Buzzer)

NT 4600 Base unit

The heart of the NT 4600 is a touch panel, which runs the visualisation software. All fill level control and display functions can be operated via the touch panel. Access is password protected. The electromechanical lead system can be started by the visualisation software.

Modbus converter

- For connection of 4-20 mA/ 2-wire sensors and full detectors
- On each converter up to 4 sensors and 4 full detectors can be connected
- Provided for mounting directly on the silo

Integration of full detector incl. alarm "silo full"

- Buzzer with reset button (supplied loose, for outdoor mounting)
- One unit for all connected silos
- Alarm happens, if one of the silos gets full
- Reset of the alarm
- Provided for mounting directly on the silo

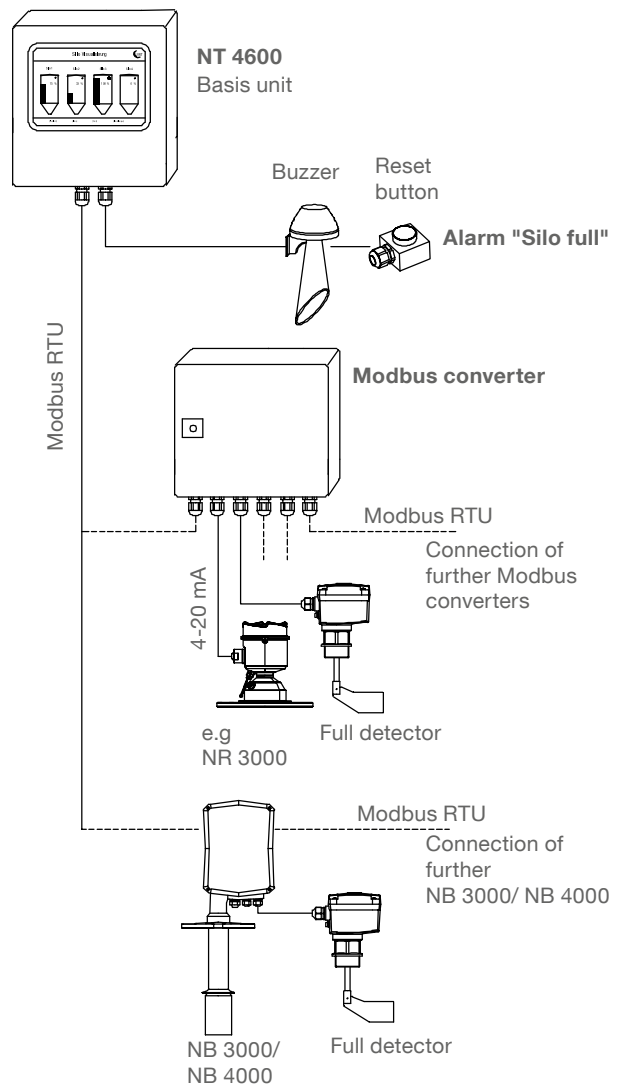

Technical data

see page 3

NT 4600

Basic unit			
NT 4600			•
pos.1	Control cabinet		
	A Touch panel without control cabinet		•
	B Touch panel completely wired in a control cabinet		•
pos.2	Input signals of level sensors		
	1 Modbus RTU (NB 3000/ NB 4000)		•
	2 4-20 mA 2-wire (e.g. NivoRadar NR 3000), use of Modbus converter Price for each 4 silos		•
	3 Mixed used: Modbus RTU/ 4-20 mA 2-wire Price for each 4 silos with 4-20 mA units		•
pos.3	Integration of full detector incl. alarm "silo full"		
	0 without		•
	A with		•
pos.4	Software language		
	A German		•
	B English		•
pos.5/ 6	Number of silos (max. 15)		•

Basic unit	Position					Order code
NT 4600	1	2	3	4	5/6	
						←



¹ Delivery touch panel for panel mounting as follows:
 Dimensions 200 x 146 x 34 mm
 Panel cutout 192 x 138 mm,
 Required supply 24V DC ±20%, 350 mA
 Sub D plug (female) 9 pole for Modbus connection

In combination with pos.3 A a Modbus I/O module for connecting of the buzzer/ reset button will be delivered as follows:
 Dimensions 98 x 52 x 27 mm, for mounting on top hat rail
 Supply 10 .. 30 V DC, 0,5 W
 Terminals for Modbus connection

NT 4700

Level display for one silo

- Evaluation of the analogue 4-20 mA signal of any sensor
- LED-Display in percentage, height, volume or weight (implements NT 4900)
- Version for Nivobob NB 3000/ NB 4000 implements start button and indicator lamp when sensor weight is in the upper position
- Simple operation

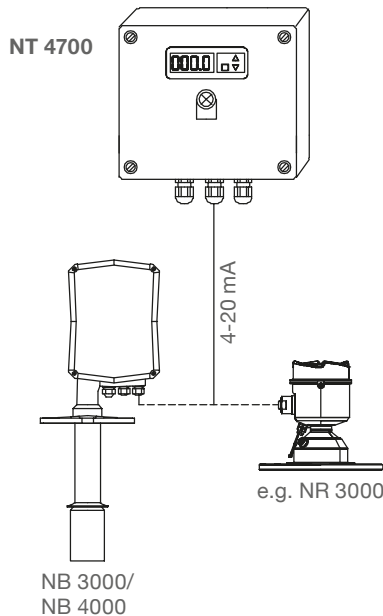

Technical data

Dimensions	182 x 180 x 90 mm (W x H x D)	
Mounting	Wall mounting	
Material	Polycarbonat	
Ingress protection	IP65	
Ambient temperature	0 .. +50°C	
Power supply	NT 4700-1/ NT 4700-2: NT 4700-5/ NT 4700-6: NT 4700-3/ NT 4700-4:	230 V 50/ 60 Hz 115 V 50/ 60 Hz 24 V DC
	NB 3000/ NB 4000:	230 V 50/ 60 Hz or 115 V 50/ 60 Hz or 24 V DC, connection is made on site
	2-wire 4-20 mA :	supplied by NT 4700-2 (integrated power converter 24 V DC) or NT 4700-4 or NT 4700-6
Power consumption	NT 4700: Connected level sensor:	10 VA see documentation of the respective sensor

NT 4700-1	Art.nr. zz110824	for NB 3000/ NB 4000,with start button and indicator lamp "upper stop position", 230 V supply	•
NT 4700-5	Art.nr. zz110836	for NB 3000/ NB 4000,with start button and indicator lamp "upper stop position", 115 V supply	•
NT 4700-3	Art.nr. zz110828	for NB 3000/ NB 4000,with start button and indicator lamp "upper stop position", 24 VDC supply	•
NT 4700-2	Art.nr. zz110825	for 2-wire 4-20 mA (e.g. NivoRadar NR 3000), 230 V supply	•
NT 4700-6	Art.nr. zz110837	for 2-wire 4-20 mA (e.g. NivoRadar NR 3000), 115 V supply	•
NT 4700-4	Art.nr. zz110829	for 2-wire 4-20 mA (e.g. NivoRadar NR 3000), 24 V DC supply	•

NT 4900

Digital display

- Level display in percentage, height, volume or weight, freely programmable
- LED display, 4 digits, 7 segment, yellow
- Operation via front buttons
- 4-20 mA input



Technical data

Dimensions	77 x 35 x 71 mm (W x H x D)		
Panel cut out	71 x 29 mm		
Material	Polycarbonat		
Ingress protection	IP65		
Ambient temperature	0 .. +50°C		
Power supply	NT 4900-1:	24 V DC/ AC	(9 - 30 V DC, 7 - 24V 50/ 60 Hz)
	NT 4900-2:	230 V 50/ 60 Hz	(+10% -20%) (Terminal 1 = L/+, Terminal 2 = N/-)
Power consumption	7 VA		
Signal input	4-20 mA aktiv (Terminal 11 = +, Terminal 12 = GND)		

Programming example:

4mA relates to a display of 0,0 tons, 20 mA to 60,0 tons

Following parameters are changed from the presets (procedure see external programming manual):

d.CnF -> i.Typ = 4-20 mA

U.oPt -> d.Pnt set on first digit from right side (decimal dot setting)

L.SCL -> 0 (lower scale value 0 tons at 4 mA)

H.SCL -> 60.0 (upper scale value 60,0 tons at 20 mA)

NT 4900-1	(Art.no. eb100370)	24 V DC/ AC	•
NT 4900-2	(Art.no. eb100380)	230 V AC	•

Accessories

Terminal box

Intermediate terminals for the wires leading to the silo (mounting e.g. on the silo frame).
 Applicable for cables of level (Modbus or 4-20 mA), limit switch, buzzer, reset button

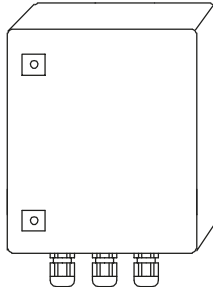

Technical data

Dimensions	200 x 300 x 120 mm (W x H x D), for wall mounting
Material	steel plate
Ingress protection	IP65
Ambient temperature	-25 .. +60°C
Terminal blocks	15 pieces grey, 5 pieces blue, 5 pieces green/ yellow; each terminal implements 3 cable inlets 2.5 mm ² , mounted on top hat rail
Cable glands	6 pieces M20 x 1.5 2 pieces M25 x 1.5

zz110835 •

Minimum order value for separate orders of spare parts or accessories is 75 €.

Cable recommendations for Modbus network

Shielded cable

Functionality up to 50 m

Manufacturer: Lapp, Type UNITRONIC LiYCY 2x 0.34, Art.no: 0034502

Twisted pair cable

Functionality up to 1,000 m

Manufacturer: Lapp, Type UNITRONIC BUS CAN 1x 2x 0.34, Art.no: 2170263

UV-protection hose with threaded hose coupling M20 x 1.5

UV protection for Modbus cable

Manufacturer: Flexa, Type Rohrflex PA6, Art.no: 0233.202.012 and Type RQG1-M, Art.no: 5020.055.018

ATEX-protection hose with threaded hose coupling M20 x 1.5

For installation of Modbus cable in ATEX Zone 21

Manufacturer: PMA, Type ESX, Art.no: ESXT-12B.50 and Type END, Art.no: BEND-M202GT