

[www.rechner-sensors.com](http://www.rechner-sensors.com)

**RECHNER  
SENSORS**

***CATALOGUE***

***FLOW  
SENSORS***



# CE



Registration No.: 1327-01



Testing laboratory accredited according to  
DIN EN ISO/IEC 17025 Reg.-No. DAT-P-048/95-00

For all transactions, the newest version of the „General Conditions of Sale and Delivery for Products and Services of the Electrical Industry ZVEI“ shall apply, along with the supplementary conditions „extended reservation of proprietary rights“, together with the supplements listed on our order confirmations and/or invoices.

All specifications are subject to change without notice. Reprint, even in part, only with our consent.  
© RECHNER Germany 04/2012 EN - Printed in EU, all rights reserved.

### **Edition April 2012**

With publication of this catalogue all former printed catalogues about RECHNER flow sensors are invalid.

All specifications are subject to change without notice. (04/2012)

# TABLE OF CONTENTS

## FLOW SENSORS

	Pages
TECHNOLOGY, FUNCTION PRINCIPLE, APPLICATION	4 - 5
MOUNTING ... AND INSTALLATION	5 - 6
ADJUSTMENT, DISPLAY ... AND PROGRAMMING	6 - 7
TYPE CODE, TECHNICAL TERMS	8
TYPES, TECHNICAL DATA, DIMENSIONS, CONNECTION DIAGRAMS	9 - 17
ACCESSORIES, FEMALE CONNECTORS, SKETCH AND NOTES	18
TYPE SELECTION IN ARTICLE NUMBER ORDER	19
TYPE SELECTION IN DESCRIPTION ORDER	19

All specifications are subject to change without notice. (04/2012)

## TECHNOLOGY • FUNCTION PRINCIPLE

The SW-600 series is a range of flow sensors according to the calorimetric measuring principle. This principle is based on the physical effect that flowing medium absorbs heat energy. These sensors contain a heat source ( $R_H$ ) and a temperature dependent measuring resistor ( $R_{M1}$ ). A second measuring resistor ( $R_{M2}$ ) monitors the temperature of the medium and compensates the measuring value of the flow during variations of temperature.

**Measuring principle Fig. 1**

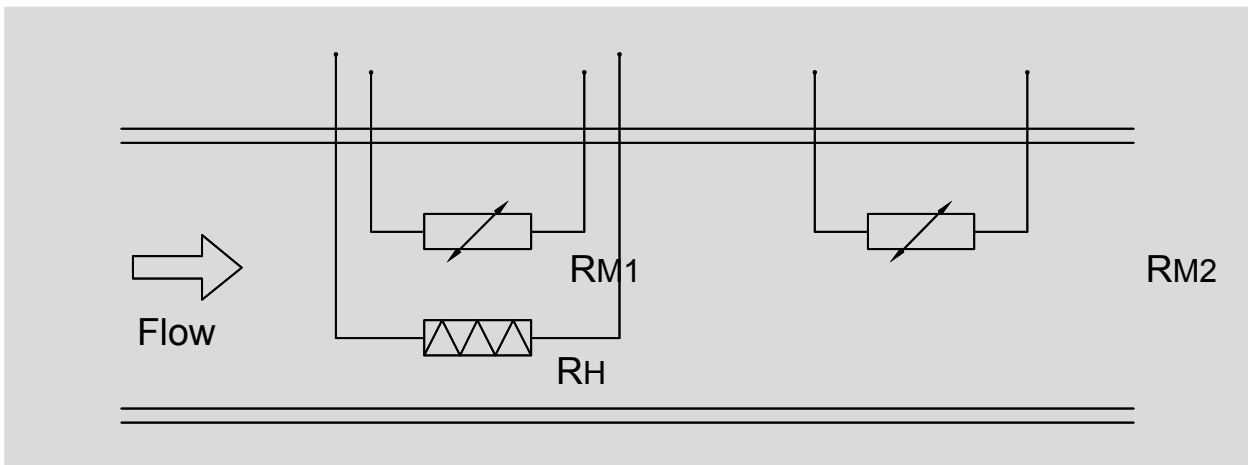

The cooling of the sensor tip by the flowing medium is registered and electronically evaluated.

**Demonstration of function Fig. 2**

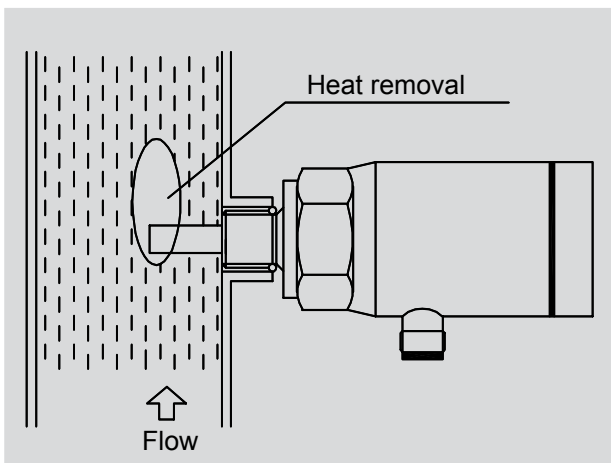

The Series SW-600 offers a range of possibilities for which measuring values can be provided e.g. increase or decrease of a determined limit value as an output signal.

There is the „...S“ Version with galvanic separated digital output (NO) and the „...IL“ Version with a programmable analogue output and 2 digital outputs (NPN/PNP) for adjustable switching points ( $S_{min}$  or  $S_{max}$ ) and hystereses.

**For the connection diagrams and technical data please see page 9...17.**

## APPLICATION

Flow sensors are an essential component of processing- and operation plants in systems technology in order to ensure operational safety. They are used for detection of liquid media and for coolant supply as well as for operation control at pumps.

Because these flow sensors operate without any mechanical contacts they are almost wear-free. Only the sensor tip has to be in the media that is flowing that requires detection. The high-quality material used for the housing minimises possible abrasion.

The „...-S“ version is used to signal the increase or decrease of a flow speed within a processing system.

The „...-IL“ version serves for measuring of flow rate in control systems in most cases but thanks to the additional option of two adjustable switching points ( $S_{min}/S_{max}$ ; NPN/PNP) it also can be used to give an alarm signal in processing systems, where a determined flow rate must be achieved or should not be exceeded. The LCD-display shows the present value for the measurement position and, all adjustments can be made (by means of the programming ring) even during the operation process. This saves time after the installation and during final operation as well as during the search for failures in your process. The analogue current signal can be evaluated over large distances and provide the actual values at this remote point.

## MOUNTING

The function of the sensors is not dependent on the mounting position. The sensor should be placed 3 pipe diameters away from bends, valves or other obstructions in order to avoid incorrect measurements (see fig. 3). If the detected liquid contains air inclusions, then exact measurements cannot be achieved whilst the sensor tip is surrounded by air bubbles. Therefore for horizontal pipes the sensor should be mounted from below. In the case of the sensor tip being subjected to heavy deposits, the installation should be made from the side (see fig. 4) and for vertical pipes the sensors should be mounted in the feed pipe.

**Mounting position fig. 3**

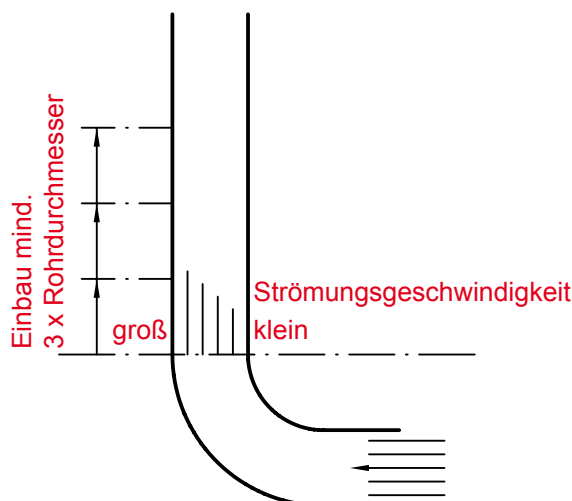

**Side mounting fig. 4**

Sensor tip should be completely in the pipe up to a minimum of the beginning of the thread .

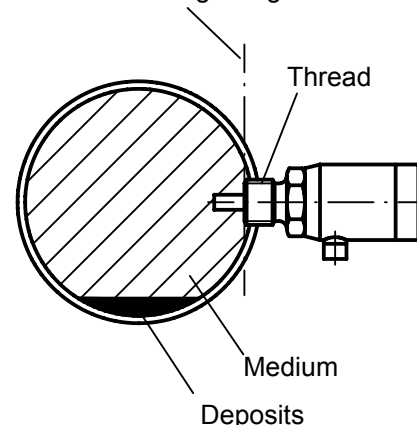

## INSTALLATION

When mounting the sensor in the corresponding pipeline one has to make sure that the complete sensor tip is surrounded by the medium that is being monitored.

### Pipe mounting in the cross-section fig. 5

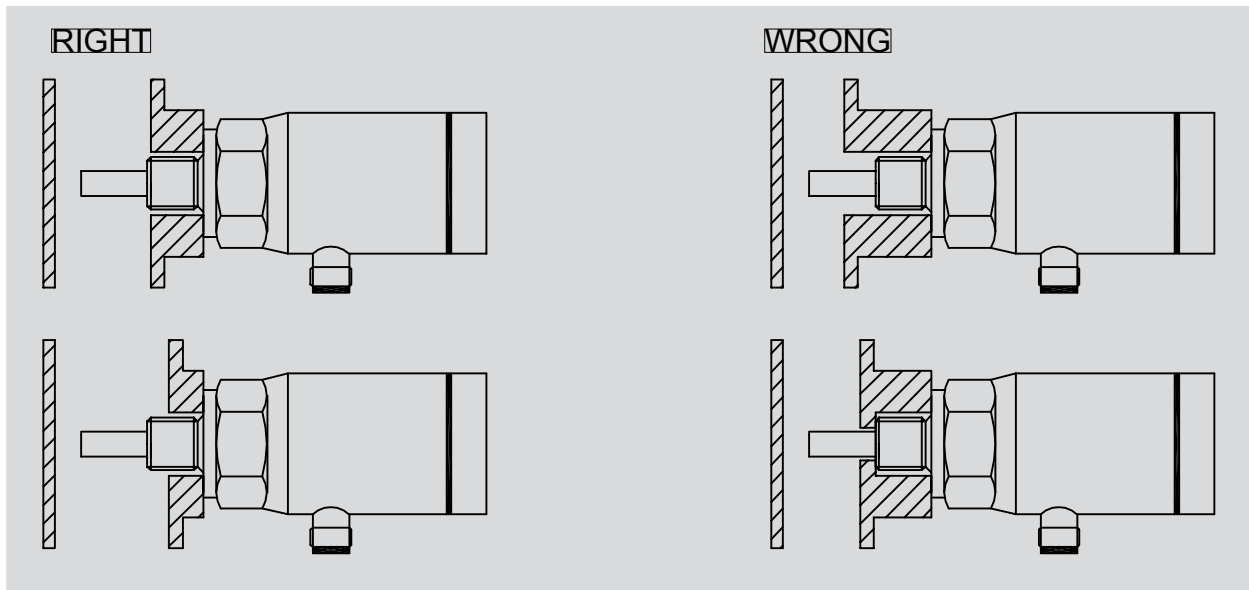

For the dimensions please see page 9...17.

For mounting and fixing a spanner with JS 27 is necessary

Thanks to the special design the whole sensor can be rotated to any position from the front part of the cable exit after mounting and sealing. This allows an optimal alignment of the cable as well as the display head.

Wiring of the flow sensors should be separated from heavy conductor lines as inductive peak voltages can destroy them despite the integrated protective circuit.

For the female connectors please see page 18.

## ADJUSTMENT, DISPLAY

The adjustment of the „...S“ version can be made by means of a 270° potentiometer.

When the adjusted switching point is achieved the LED display changes colour from green to red or reverse and there is also a change of the switching state of the switching output (NO).

For the „...IL“ version the measuring values are shown by means of a back-ground illuminated LCD-display. A 16 bit micro controller with a 14 bit A/D transducer and a 12 bit D/A transducer take care of the necessary operation speed and precise measurement.

# PROGRAMMING

The measuring values and output signals can be adjusted with the turning of a programming ring - this is also possible whilst wearing work gloves.

## Display fig. 6



The programming ring at the sensor head can be turned to Pos. 1 and 2. It can be removed as a key, or reverse mounted (turned by 180°) in order to prevent unintentional programming by turning the programming ring.

Two switching states (NPN / PNP) can be adjusted as switching points S1 and S2 (in %) for increase or decrease of process values (Smin / Smax adjustment). The value of each switching point and the hysteresis (in %) for each can be adjusted independently.

Example:

**S1 max. adjustment fig. 7**

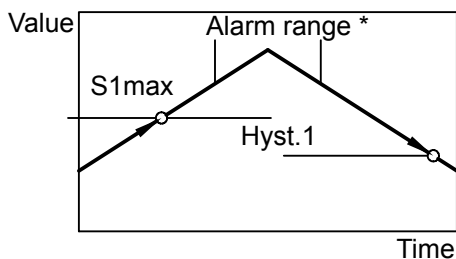

**S1 min adjustment fig. 8**

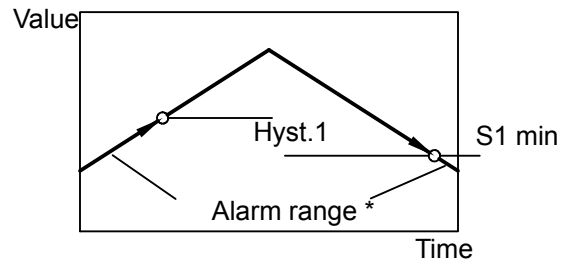

\* within the alarm range the red LED and the display flickers at the sensor head

The switching outputs can give reverse output signals, by reverse connection of the NPN / PNP function.

For the connection diagram please see page 9...17.

With increasing flow rates the analogue output gives a rising output signal 4(0)...20 mA. The values 4(0) mA are programmable in the code mode.

Further possible programming options in the code mode are:

- the filter  
this means, the time of response (sensitivity against flow changes) is adjustable from 0,2 s up to 32 s (filter-off programming is possible)
- the display range (start and end value)  
this means, the display value (0...100%) can be programmed for the optimal resolution of the flow range of the process (max. measuring range see technical data).

## TYPE CODE

**SW-.....-.....-.....-.....**

Flow sensor

Serial number

Mounting thread

- M 12x1 • G 1/4" • G 1/2"
- .../28 = with spanner JS 27
- TRI (Triclamp)

If existing

02 = large measuring range

S = function normally open (NO)

IL = function analogue + 2 switching outputs

PNP / NPN each output programmable as

Smin or Smax with programmable hystereses

If existing

length of the triclamp connection

Other process connection on request.

## TECHNICAL TERMS

**Reaction time**

The time during which a flow change is determined and a signal is given by an adjusted flow sensor.

**Measuring range**

The range within which the sensor can be adjusted.

**Temperature gradient**

Specifies the time in which the flow sensor is able to compensate temperature variations. Larger temperature variation per unit of time, than specified in the temperature gradient, may cause short-term malfunction.

**Permitted ambient temperature**

The maximum possible ambient temperature of the media in respect to the flow sensor.

The products of Rechner Industrie-Elektronik GmbH are designed and checked in accordance with the latest standards and specifications, DIN - VDE - IEC, for electric and electronic instruments. For new and revised products the newest standards are always used.





**Calorimetric flow sensor  
for liquids  
SW-600-...-IL**

- Analog output 4(0) - 20 mA
- Two switching outputs
- Microprocessor controlled
- Programmable



Certificate:

**Technical data**

Measuring range, depended on material	1 - 300 cm / s (H <sub>2</sub> O: 150 cm / s)
Repeat accuracy	1 %
Switching point, Hysteresis	Adjustable
<b>Type</b>	<b>SW-600-M12/28-IL</b>
<b>Art.-No.</b>	<b>544 100</b>
Process connection	M 12 X 1
Operating voltage (U <sub>B</sub> )	18...30 V DC
Permitted residual ripple max.	10 %
Analog output	4(0) - 20 mA, 2(0) - 10 V with 500 Ohm
Switching outputs	PNP, NPN / max 300 mA in total
No-load current (I <sub>o</sub> )	Typ. 60 mA
Response- time	Typ. 2 s
Temperature gradient	Typ. 4 K / s
Operating pressure	200 bar
Permitted ambient temperature	0...+70 °C
Display	LCD Display (32 x 16 pixel), LED red
Degree of protection IEC 60529	IP 67
Connection	Plug-in connector M 12 x 1, 5 pole
Material in contact with medium	Stainless steel no. 1.4571 (VA)
Housing	Stainless steel 1.4504 (VA)
Glass	Mineral glass tempered
Magnet	Cobalt Samarium

All specifications are subject to change without notice. (04/2012)

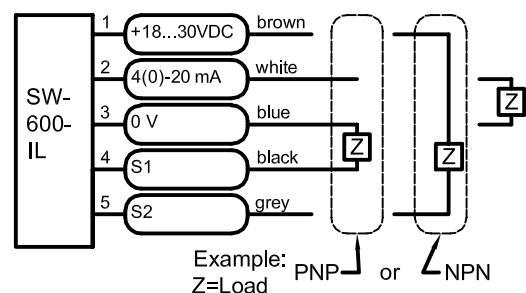
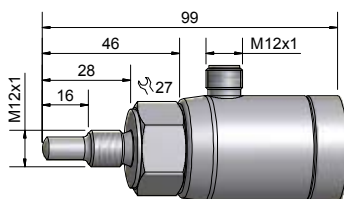



### Calorimetric flow sensor for liquids SW-600-...-IL(-02)

- Analog output 4(0) - 20 mA
- Two switching outputs
- Microprocessor controlled
- Programmable

Certificate:



#### Technical data

Measuring range, dependet on material	1 - 300 cm / s (H <sub>2</sub> O: 150 cm / s)	1 - 500 cm / s (H <sub>2</sub> O: 300 cm / s)
Repeat accuracy	1 %	1 %
Switching point, Hysteresis	Adjustable	Adjustable
<b>Type</b>	<b>SW-600-G1/4"/28-IL</b>	<b>SW-600-G1/4"/28-IL-02</b>
<b>Art.-No.</b>	<b>544 120</b>	<b>544 130</b>
Process connection	G 1/4"	G 1/4"
Operating voltage (U <sub>b</sub> )	18...30 V DC	18...30 V DC
Permitted residual ripple max.	10 %	10 %
Analog output	4(0) - 20 mA, 2(0) - 10 V with 500 Ohm	4(0) - 20 mA, 2(0) - 10 V with 500 Ohm
Switching outputs	PNP, NPN / max 300 mA in total	PNP, NPN / max 300 mA in total
No-load current (I <sub>0</sub> )	Typ. 60 mA	Typ. 60 mA
Response- time	Typ. 2 s	Typ. 2 s
Temperature gradient	Typ. 4 K / s	Typ. 4 K / s
Operating pressure	200 bar	200 bar
Permitted ambient temperature	0...+70 °C	0...+70 °C
Display	LCD Display (32 x 16 pixel), LED red	LCD Display (32 x 16 pixel), LED red
Degree of protection IEC 60529	IP 67	IP 67
Connection	Plug-in connector M 12 x 1, 5 pole	Plug-in connector M 12 x 1, 5 pole
Material in contact with medium	Stainless steel no. 1.4571 (VA)	Stainless steel no. 1.4571 (VA)
Housing	Stainless steel 1.4504 (VA)	Stainless steel 1.4504 (VA)
Glass	Mineral glass tempered	Mineral glass tempered
Magnet	Cobalt Samarium	Cobalt Samarium

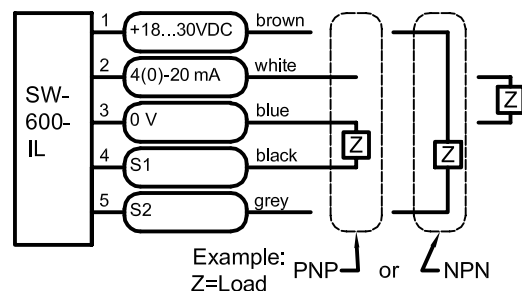
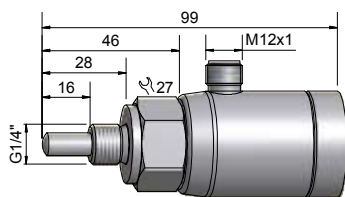

All specifications are subject to change without notice. (04/2012)



**Calorimetric flow sensor  
for liquids  
SW-600-...-IL with PTFE-coated sensor tip**

- Nonstick PTFE coating
- Analog output 4(0) - 20 mA
- Two switching outputs
- Microprocessor controlled
- Programmable

Certificate:



**Technical data**

Measuring range, depended on material	1 - 300 cm / s (H <sub>2</sub> O: 150 cm / s)
Repeat accuracy	1 %
Switching point, Hysteresis	Adjustable
<b>Type</b>	<b>SW-600-G1/4"/28-IL with PTFE-point</b>
<b>Art.-No.</b>	<b>544 121</b>
Process connection	G 1/4"
Operating voltage (U <sub>B</sub> )	18...30 V DC
Permitted residual ripple max.	10 %
Analog output	4(0) - 20 mA, 2(0) - 10 V with 500 Ohm
Switching outputs	PNP, NPN / max 300 mA in total
No-load current (I <sub>o</sub> )	Typ. 60 mA
Response- time	Typ. 2 s
Temperature gradient	Typ. 4 K / s
Operating pressure	200 bar
Permitted ambient temperature	0...+70 °C
Display	LCD Display (32 x 16 pixel), LED red
Degree of protection IEC 60529	IP 67
Connection	Plug-in connector M 12 x 1, 5 pole
Material in contact with medium	Stainless steel no. 1.4571 (VA) PTFE coated
Housing	Stainless steel 1.4504 (VA)
Glass	Mineral glass tempered
Magnet	Cobalt Samarium

All specifications are subject to change without notice. (04/2012)

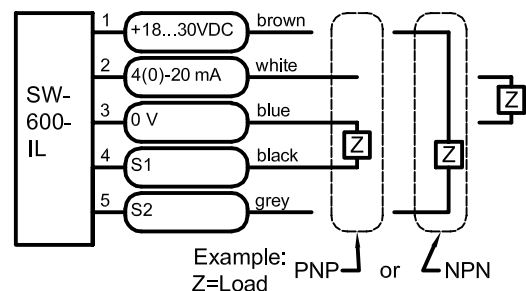
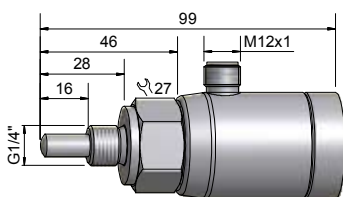



**Calorimetric flow sensor  
for liquids  
SW-600-...-IL(-02)**

- Analog output 4(0) - 20 mA
- Two switching outputs
- Microprocessor controlled
- Programmable

Certificate:



**Technical data**

Measuring range, depended on material	1 - 300 cm / s (H <sub>2</sub> O: 150 cm / s)	1 - 500 cm / s (H <sub>2</sub> O: 300 cm / s)
Repeat accuracy	1 %	1 %
Switching point, Hysteresis	Adjustable	Adjustable
<b>Type</b>	<b>SW-600-G1/2"/28-IL</b>	<b>SW-600-G1/2"/28-IL-02</b>
<b>Art.-No.</b>	<b>544 140</b>	<b>544 150</b>
Process connection	G 1/2"	G 1/2"
Operating voltage (U <sub>B</sub> )	18...30 V DC	18...30 V DC
Permitted residual ripple max.	10 %	10 %
Analog output	4(0) - 20 mA, 2(0) - 10 V with 500 Ohm	4(0) - 20 mA, 2(0) - 10 V with 500 Ohm
Switching outputs	PNP, NPN / max 300 mA in total	PNP, NPN / max 300 mA in total
No-load current (I <sub>0</sub> )	Typ. 60 mA	Typ. 60 mA
Response- time	Typ. 2 s	Typ. 2 s
Temperature gradient	Typ. 4 K / s	Typ. 4 K / s
Operating pressure	200 bar	200 bar
Permitted ambient temperature	0...+70 °C	0...+70 °C
Display	LCD Display (32 x 16 pixel), LED red	LCD Display (32 x 16 pixel), LED red
Degree of protection IEC 60529	IP 67	IP 67
Connection	Plug-in connector M 12 x 1, 5 pole	Plug-in connector M 12 x 1, 5 pole
Material in contact with medium	Stainless steel no. 1.4571 (VA)	Stainless steel no. 1.4571 (VA)
Housing	Stainless steel 1.4504 (VA)	Stainless steel 1.4504 (VA)
Glass	Mineral glass tempered	Mineral glass tempered
Magnet	Cobalt Samarium	Cobalt Samarium

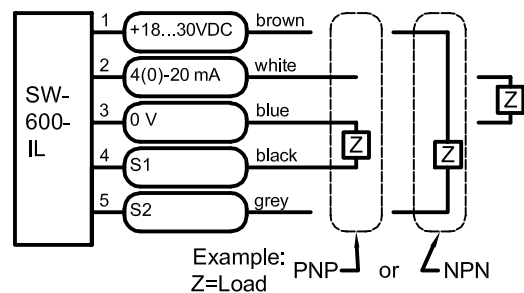
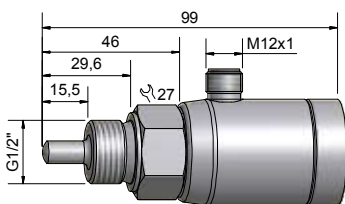

All specifications are subject to change without notice. (04/2012)



**Calorimetric flow sensor  
for liquids  
SW-600-TRI-...-IL**

- Triclamp for food industry
- Analog output 4(0) - 20 mA
- Two switching outputs
- Microprocessor controlled
- Programmable

Certificate:



**Technical data**

Measuring range, depended on material	1 - 300 cm / s (H <sub>2</sub> O: 150 cm / s)
Repeat accuracy	1 %
Switching point, Hysteresis	Adjustable
<b>Type</b>	<b>SW-600-TRI-56-IL</b>
<b>Art.-No.</b>	<b>544 250</b>
Process connection	TRICLAMP Ø 50.5 mm
Operating voltage (U <sub>B</sub> )	18...30 V DC
Permitted residual ripple max.	10 %
Analog output	4(0) - 20 mA, 2(0) - 10 V with 500 Ohm
Switching outputs	PNP, NPN / max 300 mA in total
No-load current (I <sub>o</sub> )	Typ. 60 mA
Response- time	Typ. 2 s
Temperature gradient	Typ. 4 K / s
Operating pressure	200 bar
Permitted ambient temperature	0...+70 °C
Display	LCD Display (32 x 16 pixel), LED red
Degree of protection IEC 60529	IP 67
Connection	Plug-in connector M 12 x 1, 5 pole
Material in contact with medium	Stainless steel no. 1.4571 (VA)
Housing	Stainless steel 1.4504 (VA)
Glass	Mineral glass tempered
Magnet	Cobalt Samarium

All specifications are subject to change without notice. (04/2012)

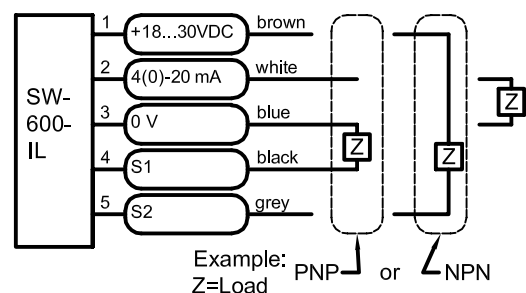
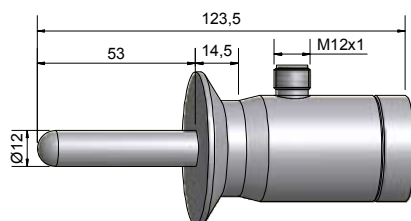



**Calorimetric flow sensor  
for liquids  
SW-600-...-S**

- Digital output
- Microprocessor controlled



Certificate:

**Technical data**

Measuring range, depended on material	1 - 300 cm / s (H <sub>2</sub> O: 150 cm / s)
Repeat accuracy	1 %
Switching point	Adjustable
<b>Type</b>	<b>SW-600-M12/28-S</b>
<b>Art.-No.</b>	<b>544 200</b>
Process connection	M 12 x 1
Operating voltage (U <sub>B</sub> )	24 V AC / DC ± 10 %
switching outputs	Galvanic separated, relay contact (normally open), max 200 mA
No-load current (I <sub>0</sub> )	Typ. 60 mA
Response- time	Typ. 2 s
Temperature gradient	Typ. 4 K / s
Operating pressure	200 bar
Permitted ambient temperature	0...+70 °C
Display	LED red / green (red < limit value , green > limit value)
Degree of protection IEC 60529	IP 67
Connection	Plug-in connector M 12 x 1, 4 pole
Material in contact with medium	Stainless steel no. 1.4571 (VA)
Housing	Stainless steel 1.4504 (VA)
Lid	PA 6.6
Short circuit protection	Yes
Reverse polarity protection	Yes

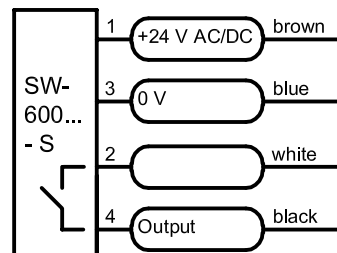
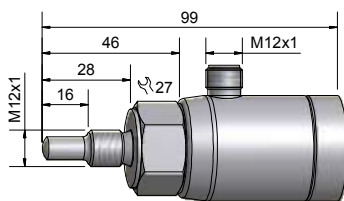

All specifications are subject to change without notice. (04/2012)



**Calorimetric flow sensor  
for liquids  
SW-600-...-S(-02)**

- Digital output
- Microprocessor controlled



Certificate:

**Technical data**

Measuring range, depended on material	1 - 300 cm / s (H <sub>2</sub> O: 150 cm / s)	1 - 500 cm / s (H <sub>2</sub> O: 300 cm / s)
Repeat accuracy	1 %	1 %
Switching point	Adjustable	Adjustable
<b>Type</b>	<b>SW-600-G1/4"/28-S</b>	<b>SW-600-G1/4"/28-S-02</b>
<b>Art.-No.</b>	<b>544 220</b>	<b>SW 0004</b>
Process connection	G 1/4"	G 1/4"
Operating voltage (U <sub>B</sub> )	24 V AC / DC ± 10 %	24 V AC / DC ± 10 %
switching outputs	Galvanic separated, relay contact (normally open), max 200 mA	Galvanic separated, relay contact (normally open), max 200 mA
No-load current (I <sub>0</sub> )	Typ. 60 mA	Typ. 60 mA
Response- time	Typ. 2 s	Typ. 2 s
Temperature gradient	Typ. 4 K / s	Typ. 4 K / s
Operating pressure	200 bar	200 bar
Permitted ambient temperature	0...+70 °C	0...+70 °C
Display	LED red / green (red < limit value, green > limit value)	LED red / green (red < limit value, green > limit value)
Degree of protection IEC 60529	IP 67	IP 67
Connection	Plug-in connector M 12 x 1, 4 pole	Plug-in connector M 12 x 1, 4 pole
Material in contact with medium	Stainless steel no. 1.4571 (VA)	Stainless steel no. 1.4571 (VA)
Housing	Stainless steel 1.4504 (VA)	Stainless steel 1.4504 (VA)
Lid	PA 6.6	PA 6.6
Short circuit protection	Yes	Yes
Reverse polarity protection	Yes	Yes

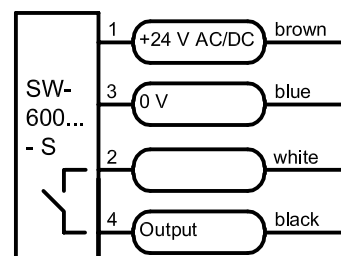
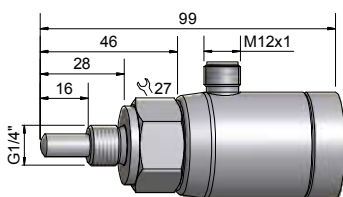

All specifications are subject to change without notice. (04/2012)



**Calorimetric flow sensor  
for liquids  
SW-600-...-S with PTFE coated sensor tip**

- Nonstick PTFE coating
- Digital output
- Microprocessor controlled

Certificate:



**Technical data**

Measuring range, depended on material	1 - 300 cm / s (H <sub>2</sub> O: 150 cm / s)
Repeat accuracy	1 %
Switching point	Adjustable
<b>Type</b>	<b>SW-600-G1/4"/28-S with PTFE-point</b>
<b>Art.-No.</b>	<b>544 221</b>
Process connection	G 1/4"
Operating voltage (U <sub>B</sub> )	24 V AC / DC ± 10 %
Switching outputs	Galvanic separated, relay contact (normally open), max 200 mA
No-load current (I <sub>0</sub> )	Typ. 60 mA
Response- time	Typ. 2 s
Temperature gradient	Typ. 4 K / s
Operating pressure	200 bar
Permitted ambient temperature	0...+70 °C
Display	LED red / green (red < limit value, green > limit value)
Degree of protection IEC 60529	IP 67
Connection	Plug-in connector M 12 x 1, 4 pole
Material in contact with medium	Stainless steel no. 1.4571 (VA), PTFE coated
Housing	Stainless steel 1.4504 (VA)
Lid	PA 6.6
Short circuit protection	Yes
Reverse polarity protection	Yes

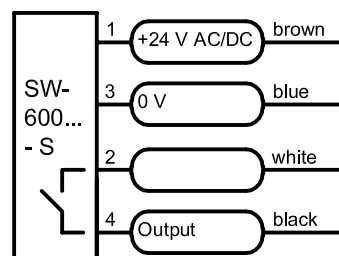
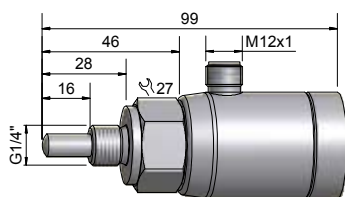

All specifications are subject to change without notice. (04/2012)





**Calorimetric flow sensor  
for liquids  
SW-600-...-S(-02)**

- Digital output
- Microprocessor controlled



Certificate:

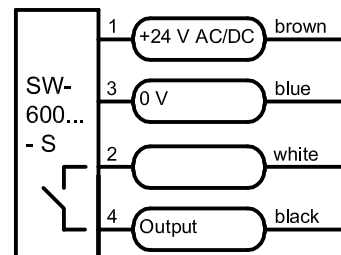
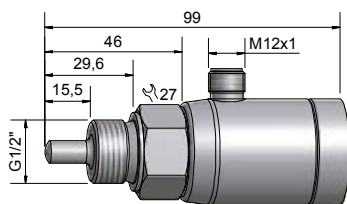

**Technical data**

Measuring range, depended on material	1 - 300 cm / s (H <sub>2</sub> O: 150 cm / s)	1 - 500 cm / s (H <sub>2</sub> O: 300 cm / s)
Repeat accuracy	1 %	1 %
Switching point	Adjustable	Adjustable
<b>Type</b>	<b>SW-600-G1/2"/28-S</b>	<b>SW-600-G1/2"/28-S-02</b>
<b>Art.-No.</b>	<b>544 240</b>	<b>SW 0005</b>
Process connection	G 1/2"	G 1/2"
Operating voltage (U <sub>B</sub> )	24 V AC / DC ± 10 %	24 V AC / DC ± 10 %
Switching outputs	Galvanic separated, relay contact (normally open), max 200 mA	Galvanic separated, relay contact (normally open), max 200 mA
No-load current (I <sub>0</sub> )	Typ. 60 mA	Typ. 60 mA
Response- time	Typ. 2 s	Typ. 2 s
Temperature gradient	Typ. 4 K / s	Typ. 4 K / s
Operating pressure	200 bar	200 bar
Permitted ambient temperature	0...+70 °C	0...+70 °C
Display	LED red / green (red < limit value, green > limit value)	LED red / green (red < limit value, green > limit value)
Degree of protection IEC 60529	IP 67	IP 67
Connection	Plug-in connector M 12 x 1, 4 pole	Plug-in connector M 12 x 1, 4 pole
Material in contact with medium	Stainless steel no. 1.4571 (VA)	Stainless steel no. 1.4571 (VA)
Housing	Stainless steel 1.4504 (VA)	Stainless steel 1.4504 (VA)
Lid	PA 6.6	PA 6.6
Short circuit protection	Yes	Yes
Reverse polarity protection	Yes	Yes



All specifications are subject to change without notice. (04/2012)

## FEMALE CONNECTORS

SW-600-...	Female connector		Article-No.	IP	Connection [mm <sup>2</sup> ]	Cablelength [m]
	No.	Fig.				
...-S	36		192 900	67	4 x 0,25	5, PVC
...-IL	54		193 330	67	5 x 0,34	5, PVC

## SKETCH and NOTES

All specifications are subject to change without notice. (04/2012)

## TYPE SELECTION IN ARTICLE NUMBER ORDER

Art.-No.	Type Description	Page
544100	SW-600-M12/28-IL	9
544120	SW-600-G1/4"/28-IL	10
544121	SW-600-G1/4"/28-IL mit PTFE-Spitze	11
544130	SW-600-G1/4"/28-IL-02	10
544140	SW-600-G1/2"/28-IL	12
544150	SW-600-G1/2"/28-IL-02	12
544200	SW-600-M12/28-S	14
544220	SW-600-G1/4"/28-S	15
544221	SW-600-G1/4"/28-S mit PTFE-Spitze	16
544240	SW-600-G1/2"/28-S	17
544250	SW-600-TRI-56-IL	13
SW0004	SW-600-G1/4"/28-S-02	15
SW0005	SW-600-G1/2"/28-S-02	17

## TYPE SELECTION IN TYPE DESCRIPTION ORDER

Type Description	Art.-No.	Page
SW-600-G1/2"/28-IL	544140	12
SW-600-G1/2"/28-IL-02	544150	12
SW-600-G1/2"/28-S	544240	17
SW-600-G1/2"/28-S-02	SW0005	17
SW-600-G1/4"/28-IL	544120	10
SW-600-G1/4"/28-IL mit PTFE-Spitze	544121	11
SW-600-G1/4"/28-IL-02	544130	10
SW-600-G1/4"/28-S	544220	15
SW-600-G1/4"/28-S mit PTFE-Spitze	544221	16
SW-600-G1/4"/28-S-02	SW0004	15
SW-600-M12/28-IL	544100	9
SW-600-M12/28-S	544200	14
SW-600-TRI-56-IL	544250	13

All specifications are subject to change without notice. (04/2012)

# SENSORS FOR INDUSTRIAL AUTOMATION

**ASK FOR FURTHER CATALOGUES:  
CAPACITIVE SENSORS KAS  
CAPACITIVE SENSORS KXS  
CAPACITIVE LEVEL MEASURING SYSTEMS  
INDUCTIVE SENSORS IAS  
MAGNETO RESISTIVE SENSORS  
OPTOELECTRONIC SENSORS  
FLOW SENSORS  
CONDUCTIVITY SENSORS  
ATEX CERTIFIED PRODUCTS  
POWER SUPPLIES AND EX BARRIERS**

**YOUR REPRESENTATIVE**

**RECHNER** INDUSTRIE-ELEKTRONIK GmbH

**Gaußstraße 8-10 • 68623 Lampertheim • Germany**

Tel. (0 62 06) 50 07-0 Fax (0 62 06) 50 07-36 Fax Intl. +49 (0) 62 06 50 07-20 www.rechner-sensors.com e-mail: info@rechner-sensors.de

#### CANADA

**Rechner Automation Inc**  
348 Bronte St. South - Unit 11  
Milton, ON L9T 5B6

Tel. 9056360866  
Fax. 9056360867  
contact@rechner.com  
www.rechner.com

#### GREAT BRITAIN

**Rechner (UK) Limited**  
Unit 6, The Old Mill  
61 Reading Road  
Pangbourne, Berks, RG8 7HY

Tel. +44 118 976 6450  
Fax. +44 118 976 6451  
info@rechner-sensors.co.uk  
www.rechner-sensors.co.uk

#### PEOPLE'S REPUBLIC OF CHINA

**RECHNER SENSORS SIP CO.LTD.**  
Building H,  
No. 58, Yang Dong Road  
Suzhou Industrial Park  
Jiangsu Province

Tel. +8651267242858  
Fax. +8651267242868  
assist@rechner-sensor.cn  
www.rechner-sensor.cn

#### REPUBLIC OF KOREA (SOUTH)

**Rechner-Korea Co. Ltd.**  
A-1408 Ho,  
Keumgang Penterium IT Tower,  
Hakeuro 282, Dongan-gu  
Anyang City, Gyunggi-do, Seoul

Tel. +82 31 422 8331  
Fax. +82 31 423 83371  
sensor@rechner.co.kr  
www.rechner.co.kr

#### UNITED STATES OF AMERICA

**Rechner Electronics Ind. Inc.**  
6311 Inducon Corporate Drive,  
Suite 5  
Sanborn, NY. 14132

Tel. 8005444106  
Fax. 9056360867  
contact@rechner.com  
www.rechner.com